

Lista de Recambios / Spare part list

Nº Ident / Ident-no 004300100

Nombre / term CityLite

Cliente / customer

Proyecto / project

Fecha / stand July 2013



1.- REALIZACIÓN DE UN PEDIDO/ PLACING AN ORDER

* A la hora de pedir una pieza de recambio, deberá tener en cuenta estos diferentes aspectos: / *When ordering spare parts, the following aspects should be born in mind:*

1. Mano de la pieza: en el catálogo hay referencias que poseen mano (izquierda/ derecha) y para determinarla deberá sentarse en el asiento al cual va a ir destinado el recambio y ver la posición que ocupa (a la izquierda o a la derecha) respecto de Usted. Para aclararlo vea el siguiente croquis: / **Part side:** *in the catalogue some references have side indicated (left/ right), in order to determine which applies you should sit in the seat for which the part is intended and note which position it occupies (to the left or the right) with respect to yourself. The following drawing shows this:*

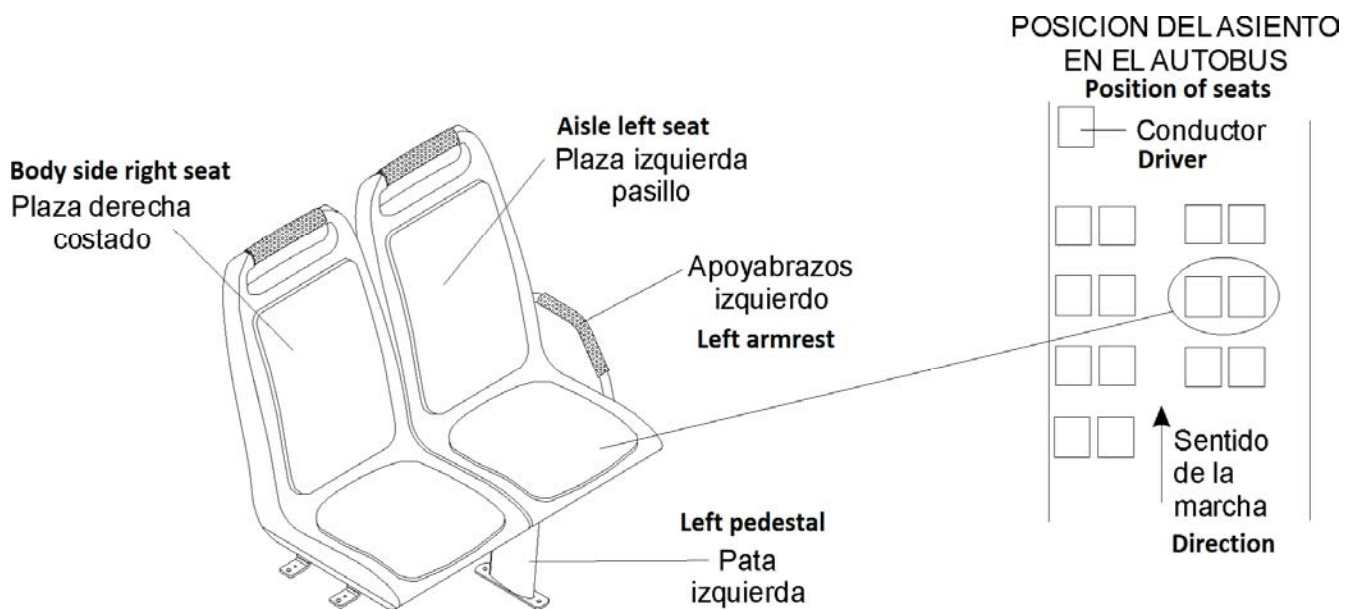

2. Color de la pieza: hay referencias que pueden tener más de un color. / **Part colour:** *some references may have more than one colour.*

3. Tipo de tejido: en todas aquellas piezas que tengan textil, deberá determinarlo exactamente para realizar el pedido e indicar el número de obra y la posición del asiento dentro del autocar. / **Textile type:** *for all parts which contain textiles, this should be exactly determined when ordering and the work number and the position of the seat within the coach indicated.*

4. Obra: si tiene cualquier duda a la hora de elegir la referencia deseada, indique el número de obra y la posición del asiento en el autocar. / **Work:** *if you have any doubts when choosing the desired reference, indicate the body number of the bus/coach and the position of the seat within the coach.*

Lista de Recambios / Spare part list

Nº Ident / Ident-no 004300100

Nombre / term CityLite









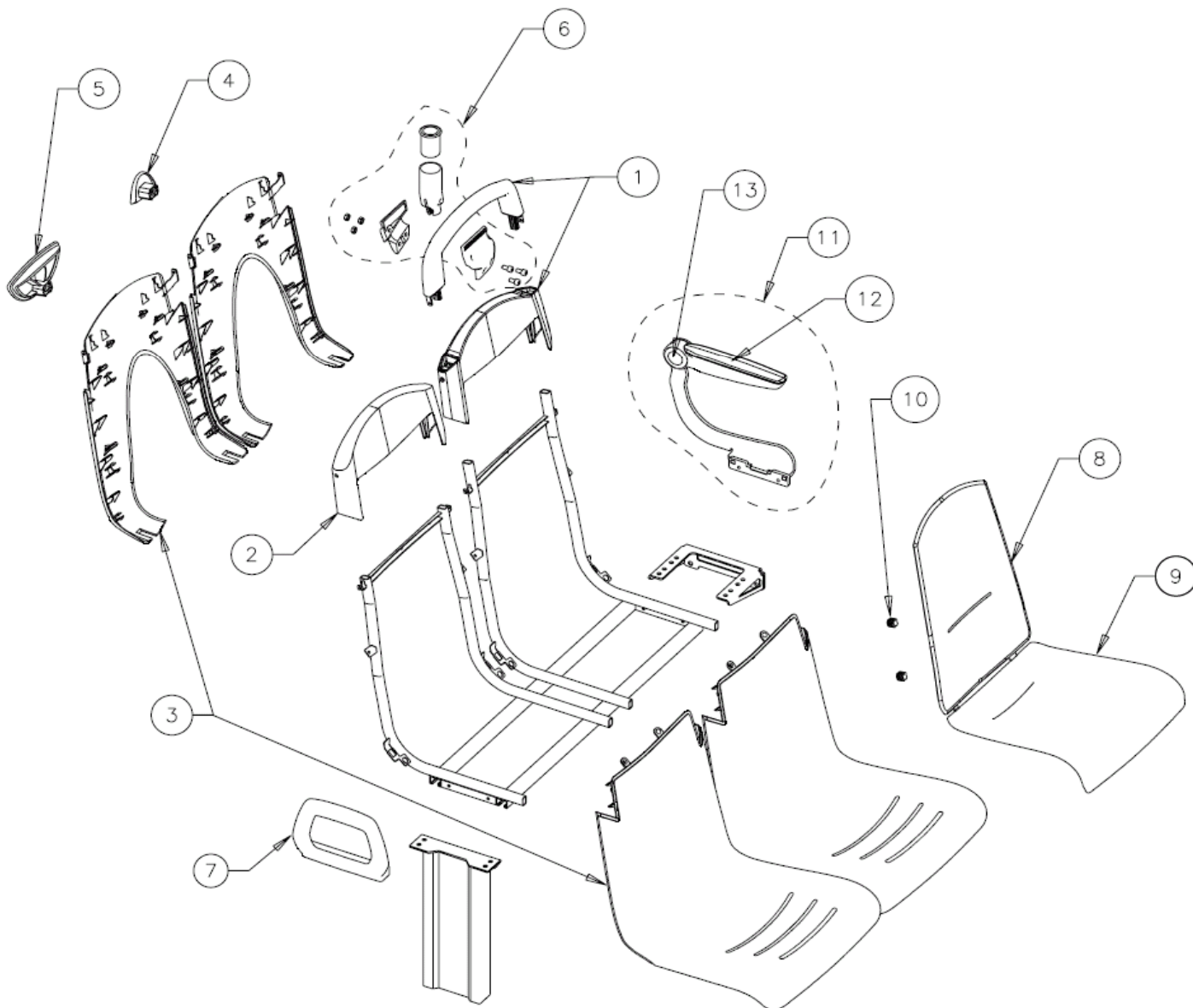

















Cliente / customer

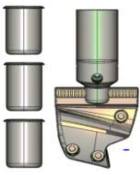

Proyecto / project

Fecha / stand July 2013



Nº	Referencia	Foto/Photo	Denominación	Description	Comentarios/Remarks
Nr	Part no.				
1.1	004340406V07-KIT		Asidero <input checked="" type="checkbox"/> Verde <input checked="" type="checkbox"/> No preparado para tapizar	Handle <input checked="" type="checkbox"/> Green <input checked="" type="checkbox"/> Not ready to upholster	Preparado para tapizar / Ready to upholster: 004343406V07-KIT
1.2	004340406A63-KIT		Asidero <input checked="" type="checkbox"/> Azul <input checked="" type="checkbox"/> No preparado para tapizar	Handle <input checked="" type="checkbox"/> Blue <input checked="" type="checkbox"/> Not ready to upholster	Preparado para tapizar / Ready to upholster: 004343406A63-KIT
1.3	004340406R07-KIT		Asidero <input checked="" type="checkbox"/> Naranja <input checked="" type="checkbox"/> No preparado para tapizar	Handle <input checked="" type="checkbox"/> Orange <input checked="" type="checkbox"/> Not ready to upholster	Preparado para tapizar / Ready to upholster: 004343406R07-KIT
1.4	004340406R09-KIT		Asidero <input checked="" type="checkbox"/> Rojo <input checked="" type="checkbox"/> No preparado para tapizar	Handle <input checked="" type="checkbox"/> Red <input checked="" type="checkbox"/> Not ready to upholster	Preparado para tapizar / Ready to upholster: 004343406R09-KIT
1.5	004340406G03-KIT		Asidero <input checked="" type="checkbox"/> Gris <input checked="" type="checkbox"/> No preparado para tapizar	Handle <input checked="" type="checkbox"/> Grey <input checked="" type="checkbox"/> Not ready to upholster	Preparado para tapizar / Ready to upholster: 004343406G03-KIT
2.1	004340424V07-KIT		Montera <input checked="" type="checkbox"/> Verde <input checked="" type="checkbox"/> No preparado para tapizar	Top Cover <input checked="" type="checkbox"/> Green <input checked="" type="checkbox"/> Not ready to upholster	Preparado para tapizar / Ready to upholster: 004343424V06-KIT
2.2	004340424A63-KIT		Montera <input checked="" type="checkbox"/> Azul <input checked="" type="checkbox"/> No preparado para tapizar	Top Cover <input checked="" type="checkbox"/> Blue <input checked="" type="checkbox"/> Not ready to upholster	Preparado para tapizar / Ready to upholster: 004343424A63-KIT
2.3	004340424R07-KIT		Montera <input checked="" type="checkbox"/> Naranja <input checked="" type="checkbox"/> No preparado para tapizar	Top Cover <input checked="" type="checkbox"/> Orange <input checked="" type="checkbox"/> Not ready to upholster	Preparado para tapizar / Ready to upholster: 004343424R07-KIT
2.4	004340424R09-KIT		Montera <input checked="" type="checkbox"/> Rojo <input checked="" type="checkbox"/> No preparado para tapizar	Top Cover <input checked="" type="checkbox"/> Red <input checked="" type="checkbox"/> Not ready to upholster	Preparado para tapizar / Ready to upholster: 004343424R09-KIT
2.5	004340424G03-KIT		Montera <input checked="" type="checkbox"/> Gris <input checked="" type="checkbox"/> No preparado para tapizar	Top Cover <input checked="" type="checkbox"/> Grey <input checked="" type="checkbox"/> Not ready to upholster	Preparado para tapizar / Ready to upholster: 004343424G03-KIT
3.1	004340402G30-KIT		Carcasas asiento <input checked="" type="checkbox"/> Color ambiente Light <input checked="" type="checkbox"/> No preparado para tapizar <input checked="" type="checkbox"/> Delantera gris G30 <input checked="" type="checkbox"/> Trasera gris G10	Seat covers <input checked="" type="checkbox"/> Light Atmosphere Colour <input checked="" type="checkbox"/> Not ready to upholster <input checked="" type="checkbox"/> Front grey G30 <input checked="" type="checkbox"/> Rear grey G10	Preparado para tapizar / Ready to upholster: 004343402G30-KIT
3.2	004340402G10-KIT		Carcasas asiento <input checked="" type="checkbox"/> Color ambiente Dark <input checked="" type="checkbox"/> No preparado para tapizar <input checked="" type="checkbox"/> Delantera gris G10 <input checked="" type="checkbox"/> Trasera gris G03	Seat covers <input checked="" type="checkbox"/> Dark Atmosphere Colour <input checked="" type="checkbox"/> Not ready to upholster <input checked="" type="checkbox"/> Front grey G10 <input checked="" type="checkbox"/> Rear grey G03	Preparado para tapizar / Ready to upholster: 004343402G10-KIT

Nº	Referencia	Foto/Photo	Denominación	Description	Comentarios/Remarks
Nr	Part no.				
4.1	004340410G10-KIT		Perchero <input checked="" type="checkbox"/> Color ambiente Light	Hook <input checked="" type="checkbox"/> Light Atmosphere Colour	
4.2	004340410G03-KIT		Perchero <input checked="" type="checkbox"/> Color ambiente Dark	Hook <input checked="" type="checkbox"/> Dark Atmosphere Colour	
5.1	004340415G10-KIT		Tapa hueco perchero <input checked="" type="checkbox"/> Color ambiente Light	Cover for hook <input checked="" type="checkbox"/> Light Atmosphere Colour	
5.2	004340415G03-KIT		Tapa hueco perchero <input checked="" type="checkbox"/> Color ambiente Dark	Cover for hook <input checked="" type="checkbox"/> Dark Atmosphere Colour	
6	004306001-KIT		Brida de barra	Handpole connector	
7	004347201G06-KIT		Brazo codera <input checked="" type="checkbox"/> Gris	Hip restraint armrest <input checked="" type="checkbox"/> Grey	
8.1	004340422-KIT		Placa de respaldo	Backrest pan	
8.2	004384300-CFG		Respaldo tapizado	Trimmed backrest	Respaldo tapizado (necesario nº de vehículo y posición asiento) Upholstered backrest (bus body number and seat position is required)
9.1	004340421-KIT		Placa de cojin	Cushion pan	
9.2	004384400-CFG		Cojin tapizado	Trimmed cushion	Respaldo tapizado (necesario nº de vehículo y posición asiento) Upholstered backrest (bus body number and seat position is required)
9.3	004343447-KIT		Placa de cojin PMR	PMR Cushion pan	
9.4	004384400-CFG		Cojin tapizado PMR	PMR trimmed cushion	Respaldo tapizado (necesario nº de vehículo y posición asiento) Upholstered backrest (bus body number and seat position is required)
10	004340416-KIT		Clip de fijacion	Fixing clips	

	Referencia	Foto/Photo	Denominación	Description	Comentarios/Remarks
	Part no.				
11.1	004304231G12-KIT		Brazo elevable completo <input checked="" type="checkbox"/> Izquierdo <input checked="" type="checkbox"/> Almohadilla Gris G12 <input checked="" type="checkbox"/> Tapas Gris G02 <input checked="" type="checkbox"/> Cuerpo apoyab. Gris G02 <input checked="" type="checkbox"/> Soporte Gris G06	Complet tip-up armrest <input checked="" type="checkbox"/> Left <input checked="" type="checkbox"/> Top Cover Grey G12 <input checked="" type="checkbox"/> Lateral Cover Grey G02 <input checked="" type="checkbox"/> Body Grey G02 <input checked="" type="checkbox"/> Metal Gris G06	
11.2	004304231R09-KIT		Brazo elevable completo <input checked="" type="checkbox"/> Izquierdo <input checked="" type="checkbox"/> Almohadilla Roja R09 <input checked="" type="checkbox"/> Tapas Gris G02 <input checked="" type="checkbox"/> Cuerpo apoyab. Gris G02 <input checked="" type="checkbox"/> Soporte Gris G06	Complet tip-up armrest <input checked="" type="checkbox"/> Left <input checked="" type="checkbox"/> Top Cover Red R09 <input checked="" type="checkbox"/> Lateral Cover Grey G02 <input checked="" type="checkbox"/> Body Grey G02 <input checked="" type="checkbox"/> Metal Gris G06	
11.3	004304232G12-KIT		Brazo elevable completo <input checked="" type="checkbox"/> Derecho <input checked="" type="checkbox"/> Almohadilla Gris G12 <input checked="" type="checkbox"/> Tapas Gris G02 <input checked="" type="checkbox"/> Cuerpo apoyab. Gris G02 <input checked="" type="checkbox"/> Soporte Gris G06	Complet tip-up armrest <input checked="" type="checkbox"/> Right <input checked="" type="checkbox"/> Top Cover Grey G12 <input checked="" type="checkbox"/> Lateral Cover Grey G02 <input checked="" type="checkbox"/> Body Grey G02 <input checked="" type="checkbox"/> Metal Gris G06	
11.4	004304232R09-KIT		Brazo elevable completo <input checked="" type="checkbox"/> Derecho <input checked="" type="checkbox"/> Almohadilla Roja R09 <input checked="" type="checkbox"/> Tapas Gris G02 <input checked="" type="checkbox"/> Cuerpo apoyab. Gris G02 <input checked="" type="checkbox"/> Soporte Gris G06	Complet tip-up armrest <input checked="" type="checkbox"/> Right <input checked="" type="checkbox"/> Top Cover Red R09 <input checked="" type="checkbox"/> Lateral Cover Grey G02 <input checked="" type="checkbox"/> Body Grey G02 <input checked="" type="checkbox"/> Metal Gris G06	
12.1	004304251G12-KIT		Brazo elevable completo <input checked="" type="checkbox"/> Almohadilla Gris G12 <input checked="" type="checkbox"/> Tapas Gris G02 <input checked="" type="checkbox"/> Cuerpo apoyab. Gris G02	Complet tip-up armrest <input checked="" type="checkbox"/> Top Cover Grey G12 <input checked="" type="checkbox"/> Lateral Cover Grey G02 <input checked="" type="checkbox"/> Body Grey G02	
12.2	004304251R09-KIT		Brazo elevable completo <input checked="" type="checkbox"/> Almohadilla Roja R09 <input checked="" type="checkbox"/> Tapas Gris G02 <input checked="" type="checkbox"/> Cuerpo apoyab. Gris G02	Complet tip-up armrest <input checked="" type="checkbox"/> Top Cover Red R09 <input checked="" type="checkbox"/> Lateral Cover Grey G02 <input checked="" type="checkbox"/> Body Grey G02	
13	004340430-G02		Tapa lateral brazo	Armrest lateral cover	

COLOURS

Front Shell		G30	RAL 7044
Front Shell		G10	RAL 7042
Rear Shell		G10	RAL 7042
Rear Shell		G03	RAL 7043
Hook		G10	RAL 7042
Hook		G03	RAL 7043
Cover for hook		G10	RAL 7042
Cover for hook		G03	RAL 7043
Handle / Top Shell		V07	110 70 60
Handle / Top Shell		A63	NCS S3560-R80B
Handle / Top Shell		R07	NCS S0585-Y30R
Handle / Top Shell		R09	3001
Handle / Top Shell		G03	RAL 7043
Top Cover		V07	110 70 60
Top Cover		A63	NCS S3560-R80B
Top Cover		R07	NCS S0585-Y30R
Top Cover		R09	3001
Top Cover		G03	RAL 7043
Hip Restraint Armrest		V07	110 70 60
Hip Restraint Armrest		A63	NCS S3560-R80B
Hip Restraint Armrest		R07	NCS S0585-Y30R
Hip Restraint Armrest		R09	3001
Hip Restraint Armrest		G06	S/ MUESTRA
Tip Up Armrest		V07	110 70 60
Tip Up Armrest		A63	NCS S3560-R80B
Tip Up Armrest		R07	NCS S0585-Y30R
Tip Up Armrest		R09	3001
Armrest Lateral Cover		G02	RAL 7037

Light Atmosphere Colour	Front Grey G30	Rear Grey G10
Dark Atmosphere Colour	Front Grey G10	Rear Grey G03