

Lista de Recambios / Spare part list

Nº Ident / Ident-no 002700100
Nombre / term ISRI 6860/875 NTS



Cliente / customer

Proyecto / project

Fecha / stand October 2014



Lista de Recambios / Spare part list

Nº Ident / Ident-no 002700100
Nombre / term ISRI 6860/875 NTS









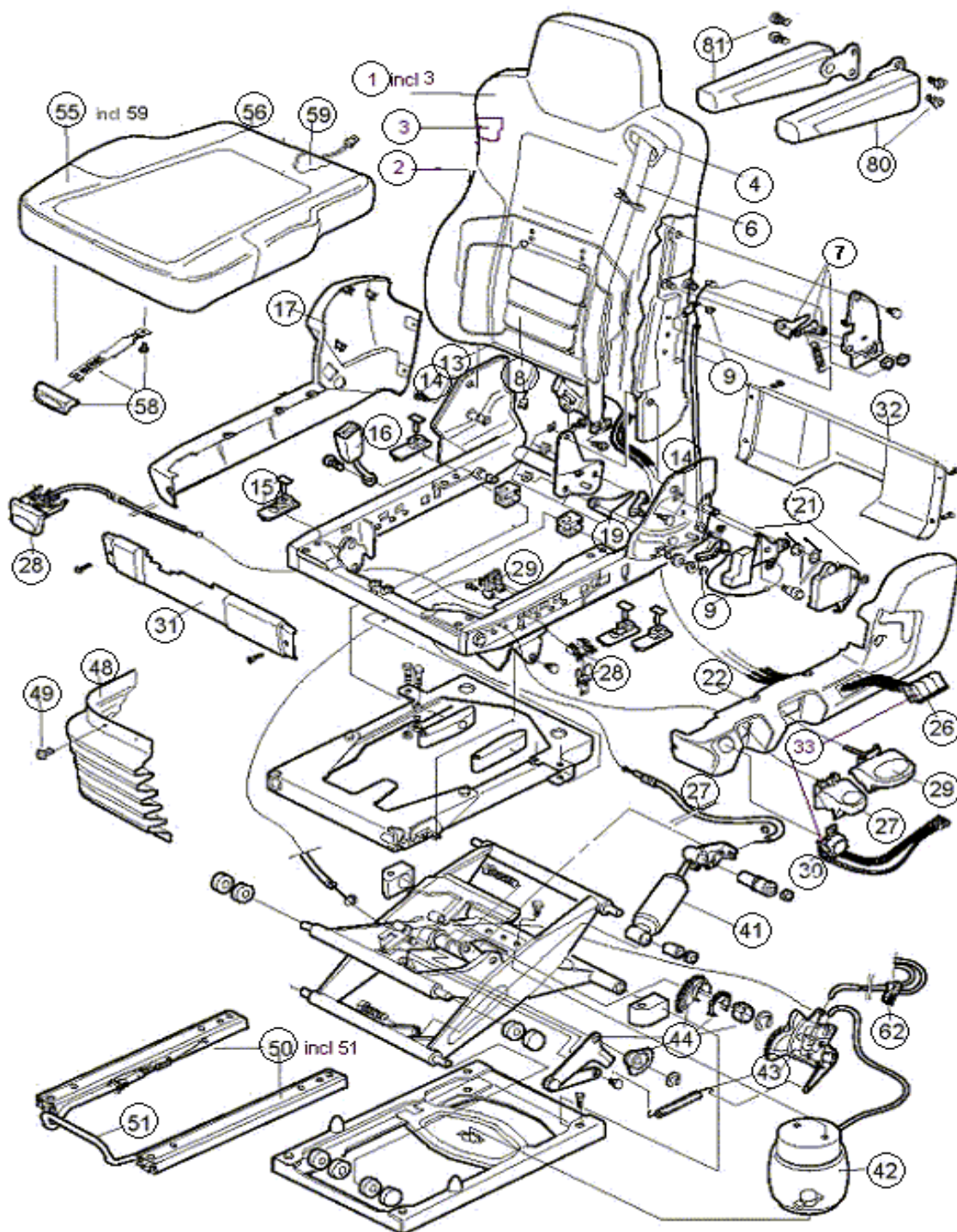

















Cliente / customer













Proyecto / project







Fecha / stand October 2014



Nº	Referencia	Foto/Photo	Denominación	Description	Comentarios/Remarks
Nr	Part no.				
1	06707-01		Respaldo sin tapizar	Backrest with belt	
2.1	002703300-CFG		Funda de respaldo sin acolchar	Backrest cover without padded	Facilitar nº obra y posicion / Body number and position is required
2.2	002703310-CFG		Funda de respaldo con acolchar	Backrest cover with padded	Facilitar nº obra y posicion / Body number and position is required
3	09169-01		Espuma de respaldo	Backrest foam	
4	929527-94		Guia para cinturón	Belt guide	
6	929527-23		Carrete cinturón	Belt	
7	928474-19		Dispositivo ajuste para zona de hombros	Catch for shoulder adjustment	
8	111441-02		Camara de aire	Air chamber	Old Ref. 113682-01
9	929527-76		Cable bowden	Bowden cable	
13	929637-01		Calefacción	Heating	
14	929527-62		Tornillos para respaldo	Screws for backrest	
15	914516-04		Guias de deslizamiento para el cojin	Slide for seat cushion	

Nº	Referencia	Foto/Photo	Denominación	Description	Comentarios/Remarks
Nr	Part no.				
16	929527-21		Hebilla cinturón	Buckle	
17	929527-59		Cubierta lateral lado derecho	Right side cover	
19	929527-101		Apoyo para respaldo	Backrest catch	
21	929527-54		Asas de respaldo	Backrest grip	
22	929527-48		Cubierta lateral lado izquierdo	Left side cover	
26	29073-02		Valvula apoyo lumbar	IPS Valve	
27	929527-42		Ajuste amortiguación	Shock absorber adjuster	
28	929527-40		Regulación de la inclinación	Inclination adjustment	
29	929527-44		Ajuste altura	Height adjustment	
30	929527-46		Dispositivo bajada	Lowering system	
31	929527-50		Cubierta delantera	Front cover	
32	929527-51		Cubierta trasera	Rear cover	

	Referencia	Foto/Photo	Denominación	Description	Comentarios/Remarks
	Part no.				
33	929527-75		Osciladores valvula	Valve actuators	
41	98889-08		Amortiguador	Shock absorber	
42	98872-19		Resorte neumático	Air spring	
43	928474-48		Valvula regulacion altura	Valve for height adjustment	
44	928462-47		Material para el bloqueo de la altura	Parts kit with height stop	
48	03177-01		Fuelle	Bellow	
49	928462-44		Material para fijacion del fuelle	Mounting material for bellow	
50	29378-01		Par de railes con soporte	Pair of rails with bracket	
51	112358D01		Soporte para railes	Bracket of rails	
55	113791-01		Cojin sin tapizar	Complete cushion without cover	
56.1	002703400-CFG		Funda cojin sin acolchar	Cushion cover without padded	Facilitar n° obra y posicion / Body number and position is required
56.2	002703410-CFG		Funda de cojin acolchada	Cushion cover with padded	Facilitar n° obra y posicion / Body number and position is required

	Referencia	Foto/Photo	Denominación	Description	Comentarios/Remarks
	Part no.				
58	929527-77		Asa para dispositivo deslizante cojin	Handle for slide cushion system	
59	09211-01		Espuma de cojin	Cushion foam	
62	929527-22		Kit de reparacion	Repair kit	
80	929651-01		Reposabrazos izquierdo	Left armrest	
81	929652-01		Reposabrazos derecho	Right armrest	
82	929623-01		Kit de tapizado	Upholstery kit	
A	38617	Not photo	Filtro de aire negro en el tubo	Black Air filter in the tube	Grey: 38617-01
B	06757-08		Plato giratorio	Swivel Plate	
C	002795001-KIT		Cojin Vibratorio	Vibrating cushion	